

元皿公司22種會議金屬桌腳介紹  
承製設計高級會議桌案例分享



# 1. A ROD系列



桌面1cm鋁板拉髮絲陽極紅銅色+鋁合金實心腳座+鋁合金插座盒

# 1. A ROD系列





# 1. A ROD系列

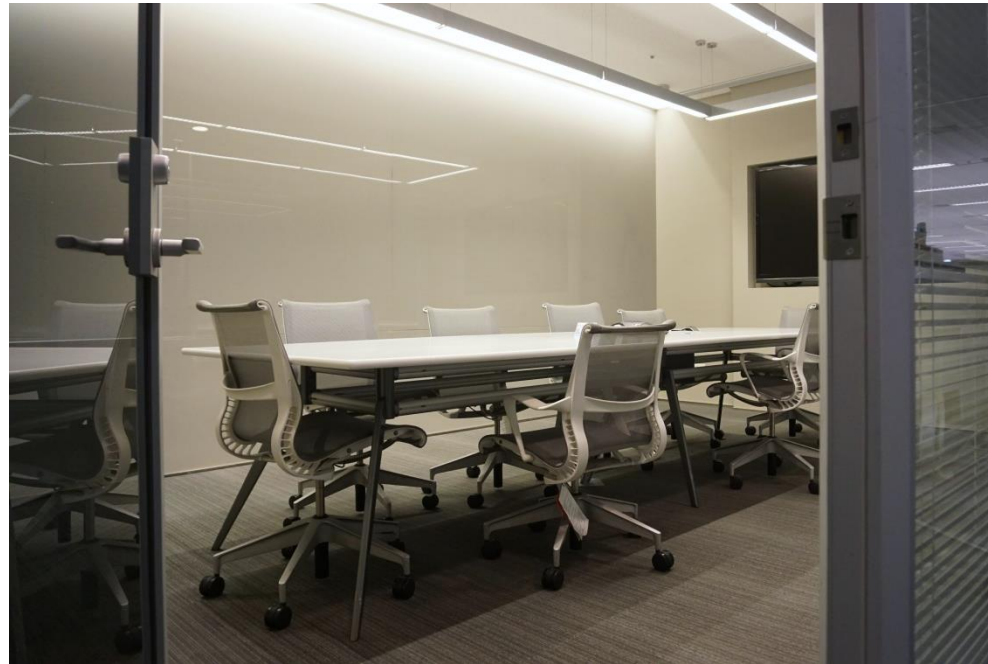

桌面1cm鋁板拉髮絲陽極青銅色+鋁合金實心腳座  
+鋁合金插座盒



# 1. A ROD系列



人造石+實心鋁腳+鋁擠橫樑

# 1. A ROD系列

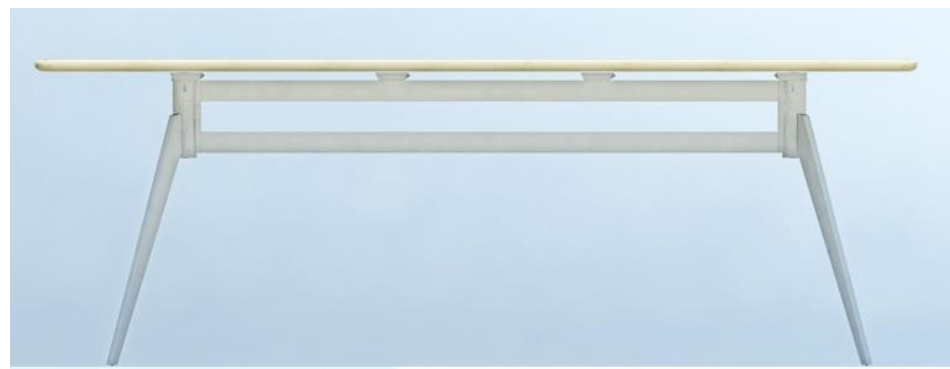

美耐板面+鋁合金腳+鋁擠橫樑

## 2. COIN TU-系列 鋁合金桌腳及橫樑





### 3. SQ系列鋁合金桌腳及橫樑



## 4. Cover系列--鋁框包桌板--鋁合金腳2種型態選擇

18mm木板

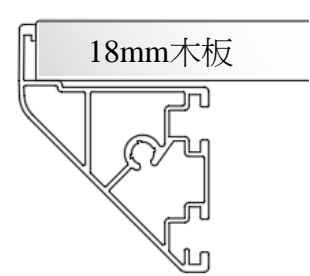



## 5. OV系列鋁合金桌腳及橫樑





## 5. OVAL系列鋁合金桌腳及橫樑



## 5. SB系列鋁合金桌腳及橫樑



# C4系列—全木質會議桌





# CEO系列--鋁邊+鋼板菱形腳座

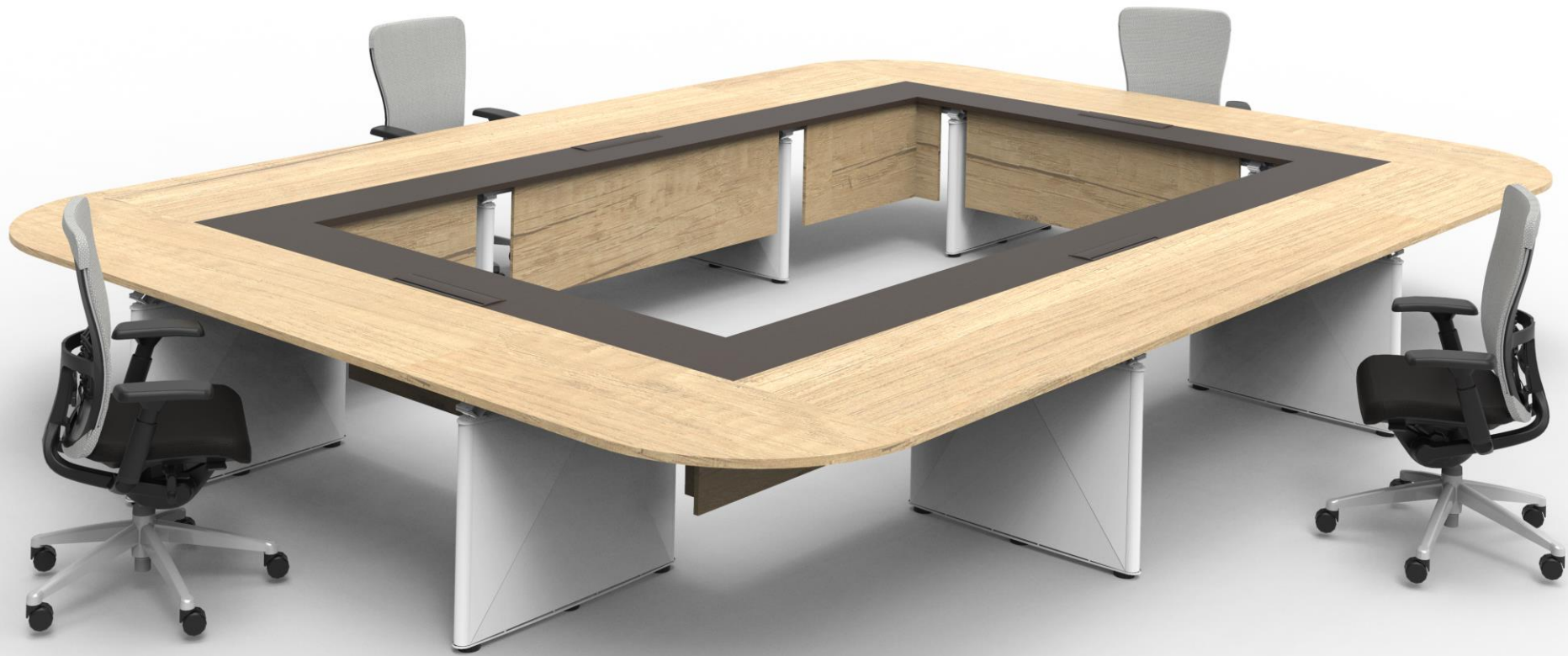

# C8系列—不鏽鋼拉絲或加鍍鈦腳座

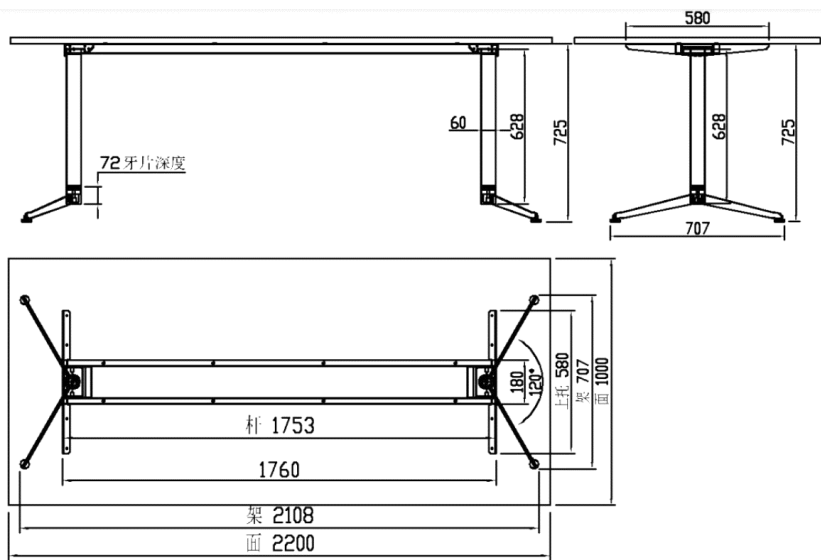



# CEO系列--鋁邊+鋼板菱形腳座



其內為空心具走線功能具多尺寸可供選擇

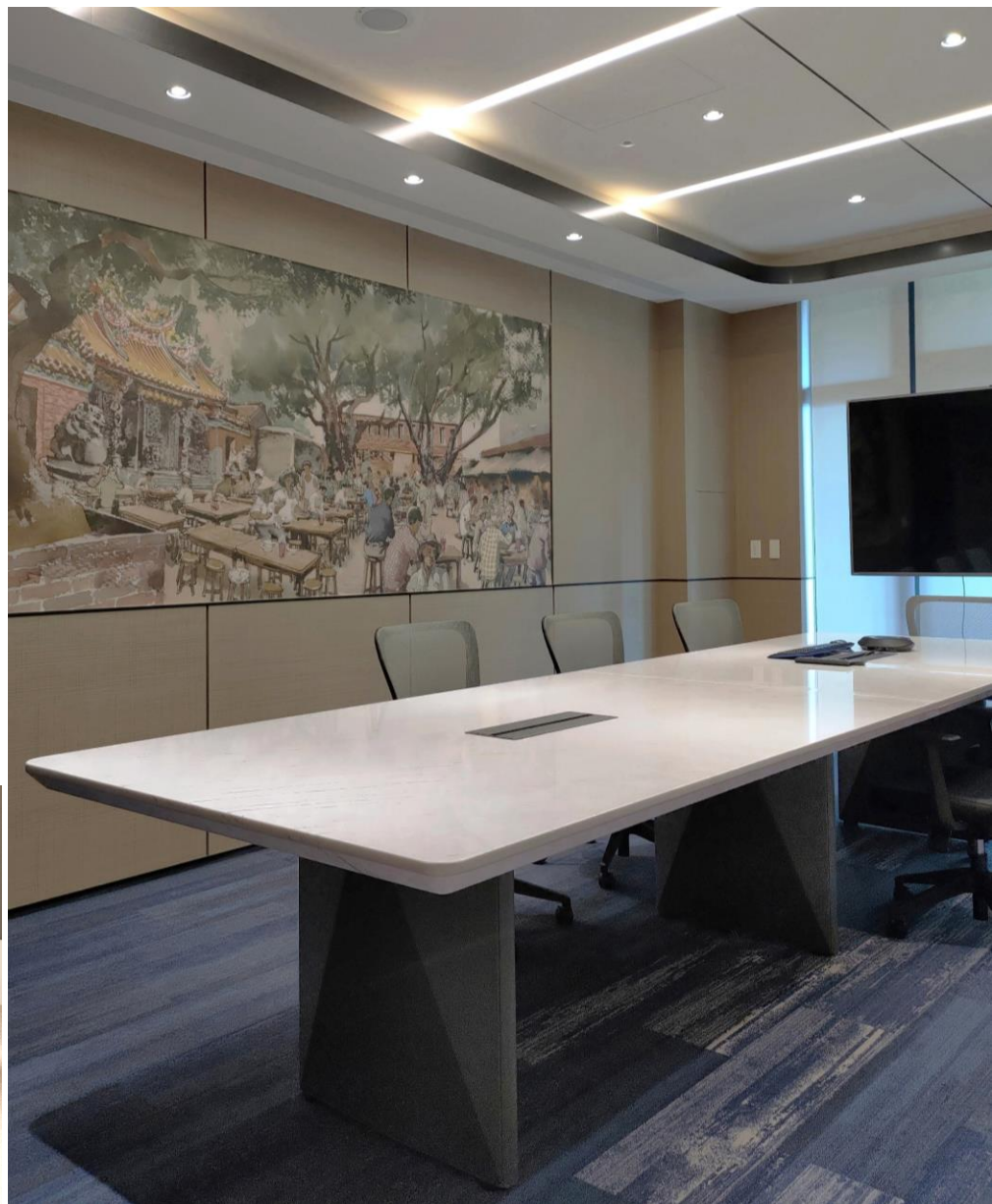

石材或木質桌面+鋁製收邊+鋼製本體之造型桌腳



## 6. Ivix鋼製桌腳及橫樑—腳座可調高低



以3cm\*6cm黑鐵腳座為主要結構,其表面為耐磨性最強之粉體塗裝,腳座並可調整高度

## 6. Ivix鋼製桌腳及橫樑—腳座可調高低



以3cm\*6cm黑鐵腳座為主要結構,其表面為耐磨性最強之粉體塗裝,腳座並可調整高度

## 6. Ivix鋼製桌腳及橫樑—腳座可調高低



以3cm\*6cm黑鐵腳座為主要結構,其表面為耐磨性最強之粉體塗裝,腳座並可調整高度



## 7. MIN SERIES-



可做：  
實心(1公分)~~較優雅&貴  
或空心腳座~~較經濟實惠



# 7. MIN SERIES



可做：  
實心(1公分)~~較優雅&貴  
或空心腳座~~較經濟實惠



## 8. HJ鋁合十字型腳座





## 9. CA桌腳



桌&几新設計:基座材質:水泥+鋁支柱





# 10.意大利進口鋁壓鑄桌腳--K SERIES

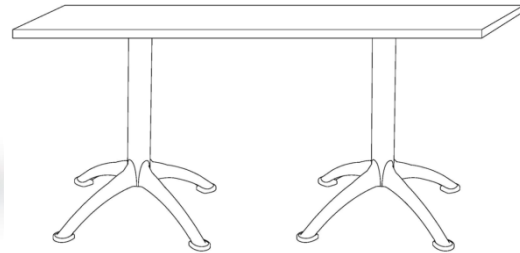

義大利SEGIS製鋁壓鑄桌腳--K SERIES



腳座有灰&銀&鍍鉻 3色可選  
桌面可選任何材質(包含玻璃)

# 10. 義大利進口鋁壓鑄桌腳--K SERIES

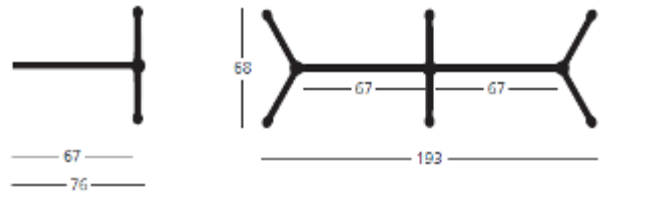
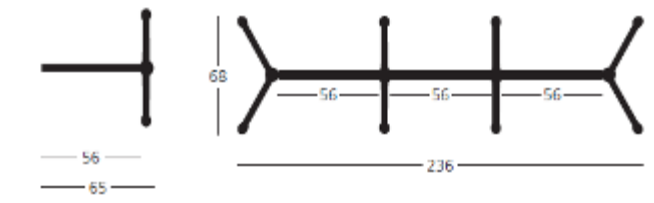
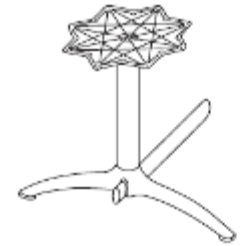
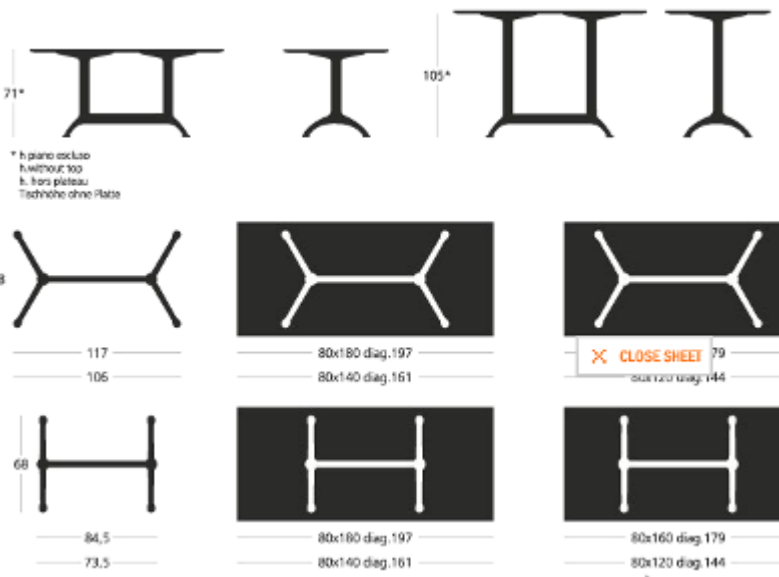



## 11. EAA 系列



桌面寬度低於110CM用  
單圓垂直管--Y型金屬腳



## 12. MOLO系列訓練教室&會議桌一可折合



台北文創大樓3F多功能會議室



# 12. MOLO系列訓練教室&會議桌一可折合



B301 办公椅 > Office Chair >  
专利号 | Patent No.

CBO 折叠办公台 < Folding Office Table >  
Size: 150 x 80 x 72.5 cm





## 14. ONE 折合桌



## 15. UJ TOUCH折合桌

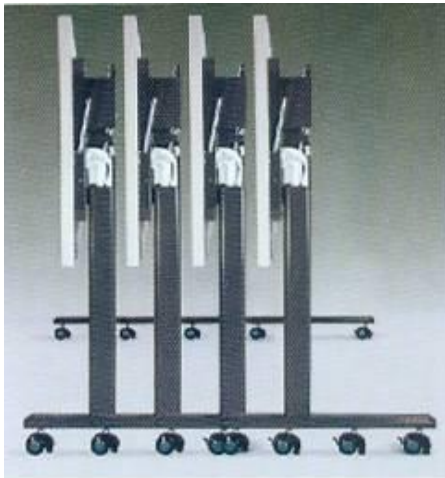

■ 整齊劃一的收納方式，讓空間多更多。



■ 獨特的收折設計，收取方便、輕鬆自如。



\*附氣壓棒可折合鋼製會議桌 美耐板面



## 16. Shiju 折合桌



\*附氣壓棒可折合鋁合金腳會議桌 美耐板面



# 16. Shiju 折合桌



Folding bookshelf

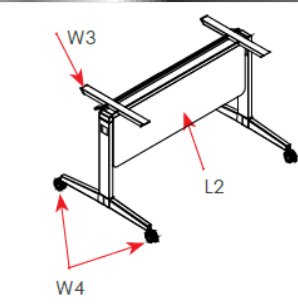

Model : LEO  
L2=1080/1380/1680MM  
W3=350/500MM  
W4=450/580/700MM  
H=725MM

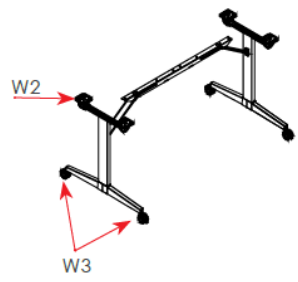

Model : LEO  
W2=400MM  
W3=450/580/700MM  
H=725MM

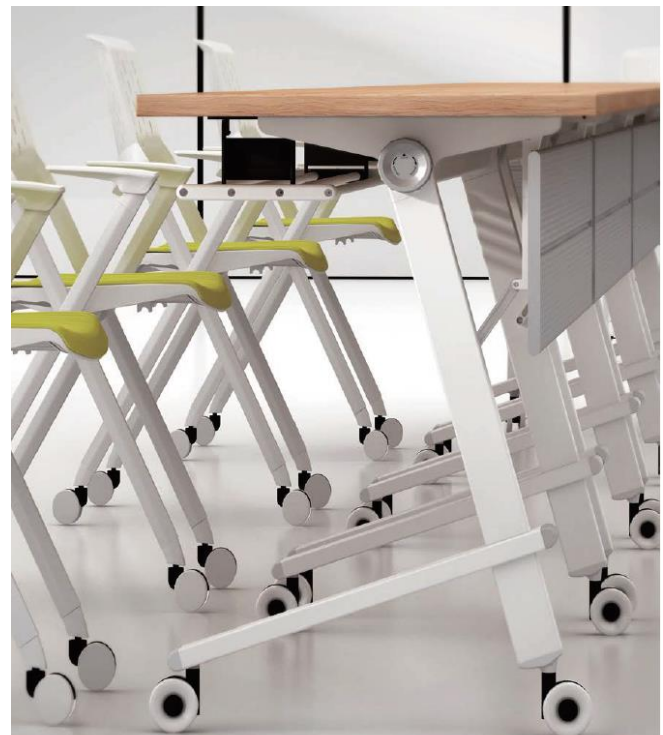
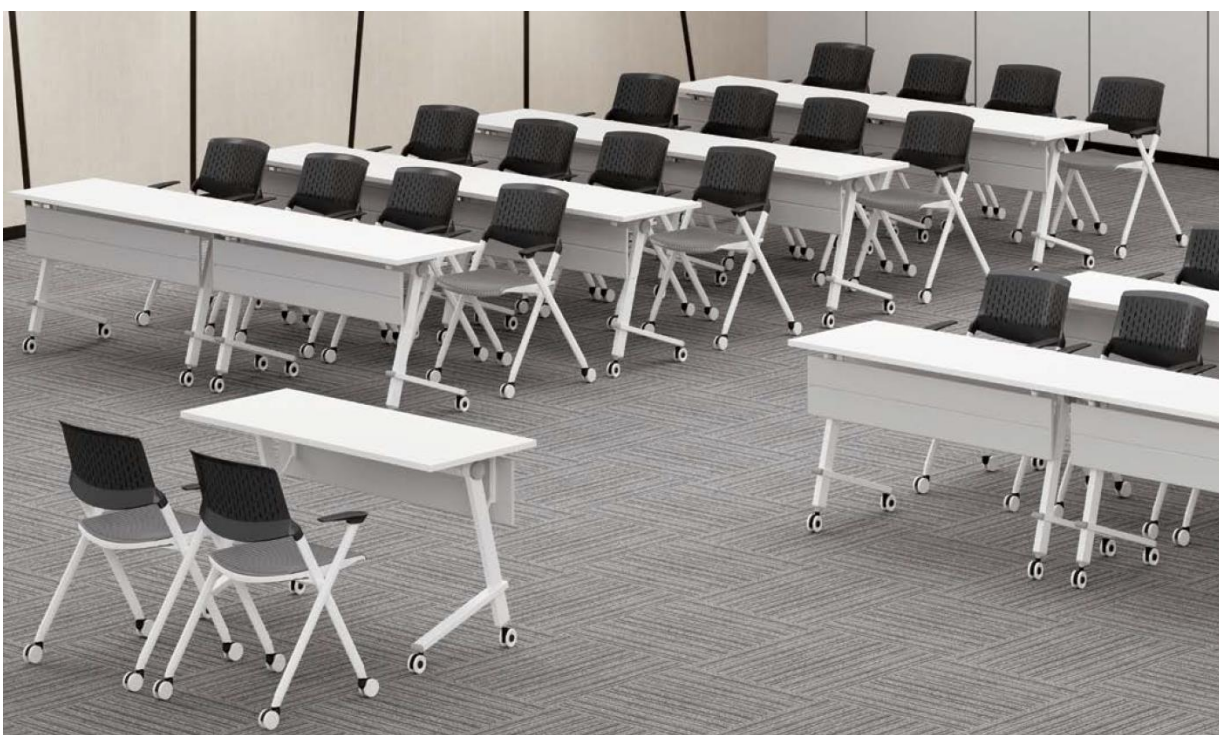

## 16. Shiju-1 折合桌





## 16. 鋼製喇叭型桌腳



下盤50CM圓\*上盤25CM圓  
中心圓管6CM直徑—全鋼製





## 17. 鋼製圓形平盤腳座



50CM圓\*8MM厚圓盤 + 6CM圓柱腳座 -- 粉體塗裝



## 18. 義大利 Segis原裝桌腳



CONI系列



# 19.義大利 Segis原裝桌腳



POLO系列





20. WA系列黑鐵腳座+實木(拼)桌板



## 21.WST系列不鏽鋼(鍍鈦)腳座



## 21.不鏽鋼或黑鐵腳座





## 22. 實木會議桌桌腳



## 23. Timber series



## 元皿公司承製設計高級會議桌案例分享



元皿公司具有豐富的經驗為許多企業設計各式型態會議桌,從平面,剖面&立面至3D模擬繪圖,均在服務範圍,同時本公司也運用過許多桌面材質,包括實木桌面&貼木皮桌面&皮革面桌面&玻璃&金屬桌面,均有熟練之技術與經驗,





# 參考案例:ING FUND (安泰投信) - 101大樓



皮革面+鋁合金腳座+鋁合金桌面插座盒



# 參考案例:台新金控大樓



鋁合金鈦色處理插座盒+烤漆玻璃+橡木染色



鋁合金鈦色處理插座盒+烤漆玻璃





# 參考案例:台新金控大樓

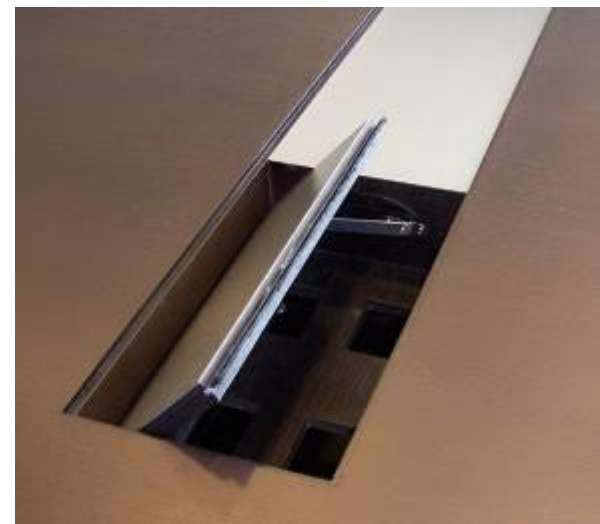

可左右互掀插座盒設計

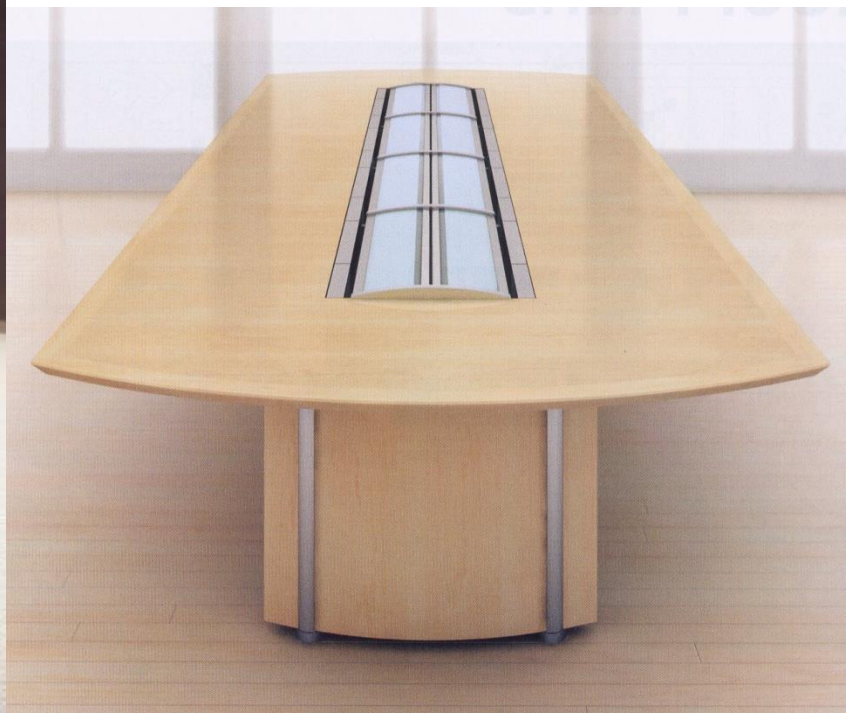

# 不鏽鋼或黑鐵製現代型會議桌





# 訂製鋁板拉髮絲陽極青銅色會議桌+鋁合金插座盒

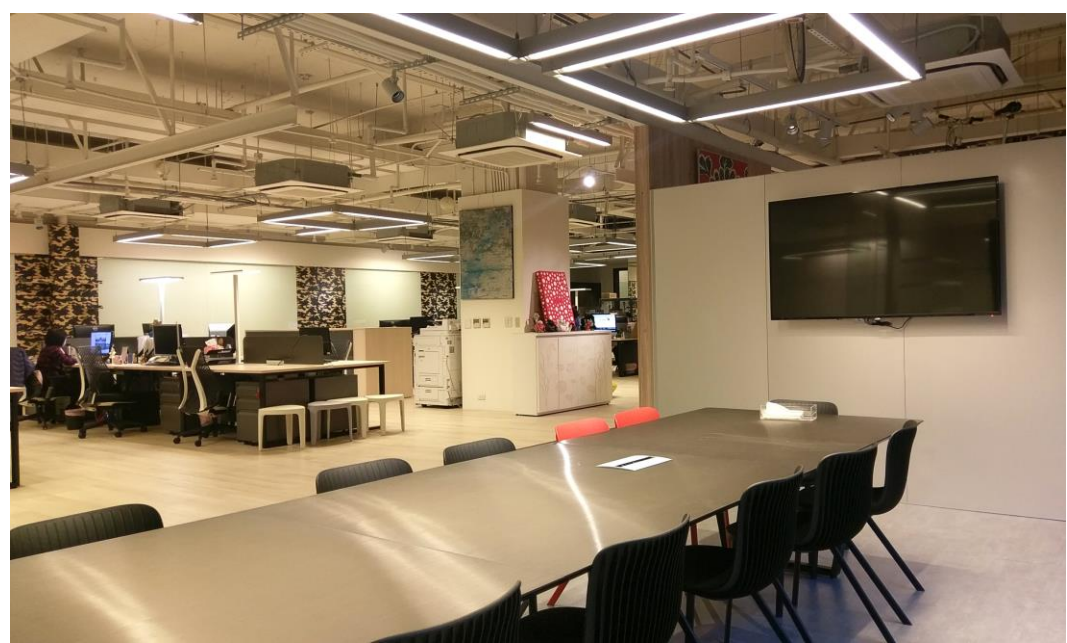
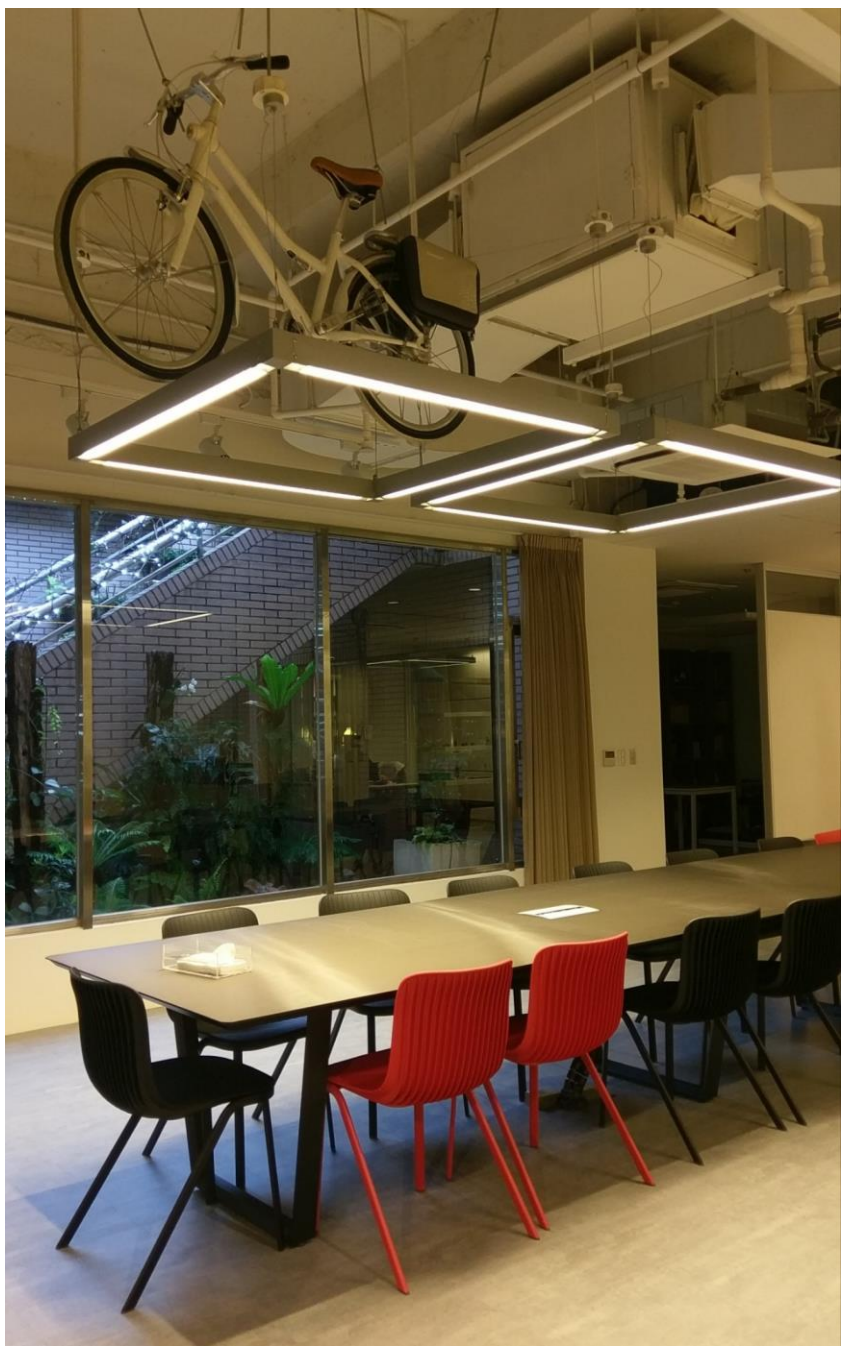



# 參考案例:板信商銀董監會議室





# 參考案例:板信商銀董監會議室

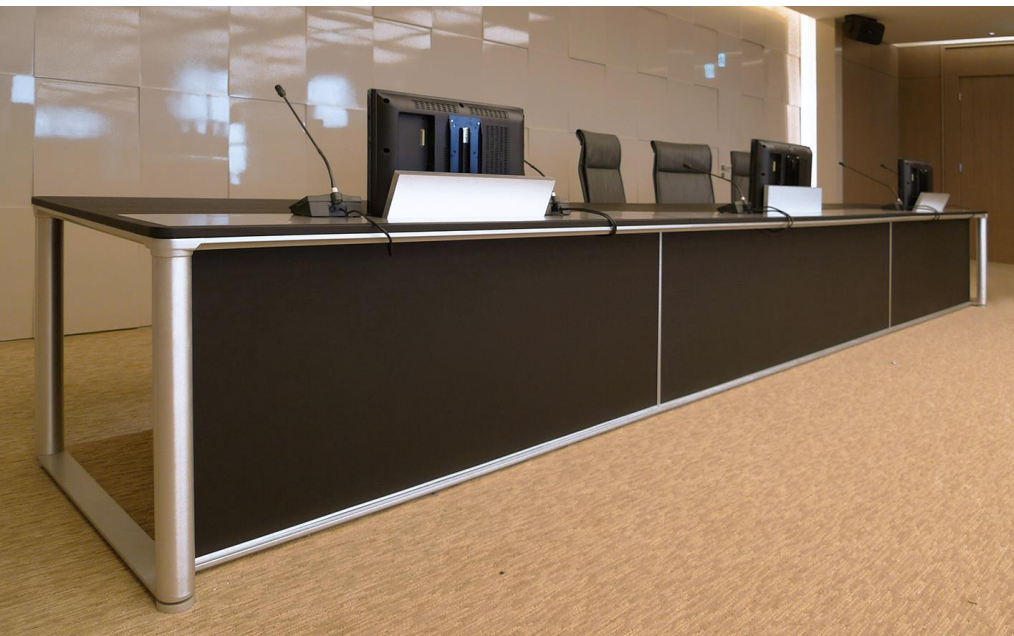



天然紅橡木皮桌面+不鏽鋼鍍鈦亂紋腳座及桌面修飾蓋板



# 松菸臺北文創大樓--富邦建設



天然紅橡木皮桌面+不鏽鋼鍍鈦亂紋腳座及桌面修飾蓋板



\* 本公司會議桌設計提供予客戶傳統手工技術,包括實木家具沙沖,打樺&皮帶鉅切割技術,同時也具現代工業CNC3度空間機械製作方式等,並提供最先進之環保塗裝方式&極儘可能提供現今最好之五金配件,,帶給客戶最耐用&最好看&最好用之會議桌

10cm白橡實木收邊+皮革面+鋁合金腳座+鋁合金桌面插座盒





10cm白橡實木收邊+皮革面+鋁合金腳座+鋁合金桌面插座盒







雪白銀弧大理石桌面—木製塗裝白色腳座







超白玻璃桌面—木製塗裝白色腳座





3.6M寬之含鋁框推拉門+優白玻璃烤白漆含鋁框推拉門+訂製會議桌



\*\*桌面馬鞍皮厚17cm切斜角設計 \*\*桌面採鋁框+烤漆玻璃雙掀設計插座盒



# 橡木實木打蝴蝶榫製作方式



# 太平洋建設&大會議桌設計圖















# 電視螢幕嵌入前檔板案例







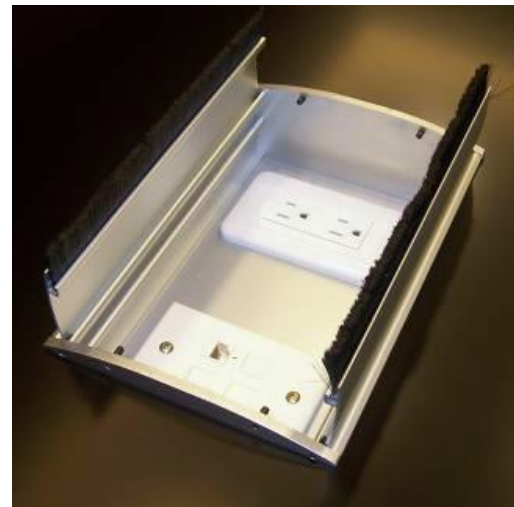

具全鋁合金雙掀式桌面插座盒,尺寸可訂做









# 中原大學Boardroom





# 元利建設-26人策略會議室







\*\*白色烤漆桌腳+義大利雕刻白桌面







期待您光臨元皿家具展示中心  
HOPE TO SEE YOU AT OUR SHOWROOM A.S.A.P.



台北市南京東路四段 56 號 11F - 1 TEL / 02-2579-0771

捷運 / 捷運台北小巨蛋站 EXIT 4，步行約 50 公尺，轉角星巴克樓上

公車 / 至南京寧安街口，過馬路向右行約 100 公尺抵達

自行開車 / 可停泊車趣（育達商職）或小巨蛋停車場，步行 5 分抵達

網址: [www.mobicrea.com.tw](http://www.mobicrea.com.tw)